

Instruction Manual

 Android Auto
  Apple Car Play

SCB-NTG4.5

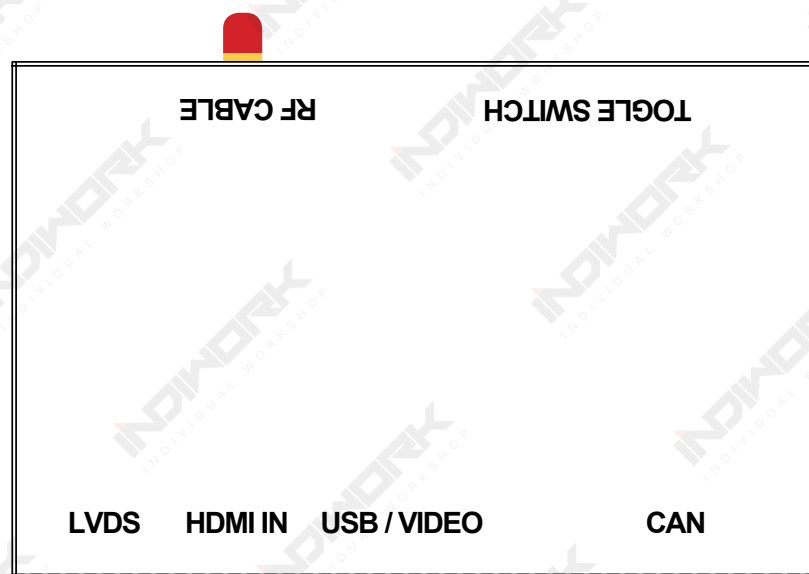

Model Name	SCB-NTG4.5
SDK Version	
MCU Version	
Manual Version	Rev. 1.1
Language	English

Main Specifications

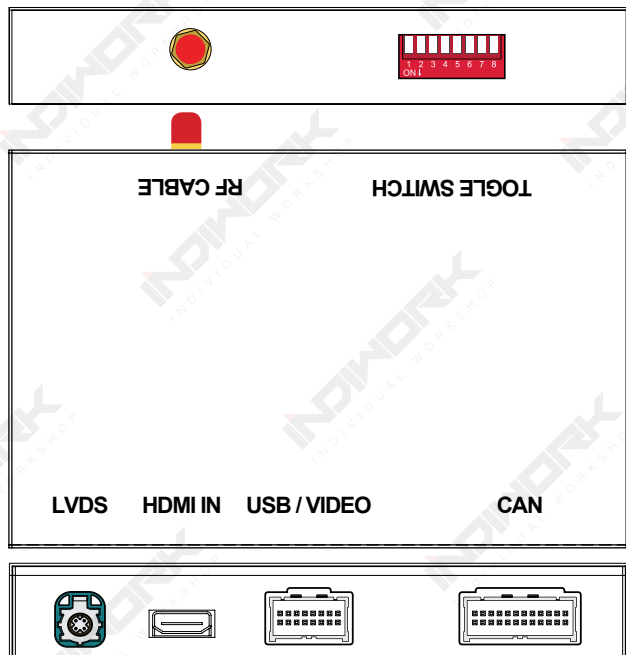

Input Voltage	12~16V DC
Rated Current	2A
Rated Power	24W
Material	Housing aluminum
Connection	Wireless , USB
Control	Original car knob control, voice control
Working Temperature	-20 ~ 80 degree

Product Warranty

Thank you for purchasing our product.
We offer the warranty for 1 year from the date of purchase.
This product has been tested and have passed under our strict and qualified control. If the failure occurred due to the carelessness of workmanship within one year after the purchase, we are responsible to repair free of charge.

- **Free service** : Manufacturing defects, When naturally occurring failures within the warranty period.

* When the warranty period has elapsed, Failure the caused by customer's mistake, Failure thecaused by natural disasters.

Warranty : One years from the original date of purchase.(12 months)

For Siri function perfect performance, we use the Car original Mic, if you Audi car is no Mic, there will can not use the siri (Andriod Auto is "OK Google") function

The CarPlay and Android Auto sound source is pass by the Aux in sound path, but when you use the Android Auto for a call ,Please connect the Car BT first.

For safety consideration, before Install the Carplay active adapter, please make sure the Power can cable pin is same the original car cable, if not ,do not install.

Components



Main Harness



LVDS Cable



AV,USB Cable



ANTENNA

Option Parts



USB To AUX Module

Body Connector specifications

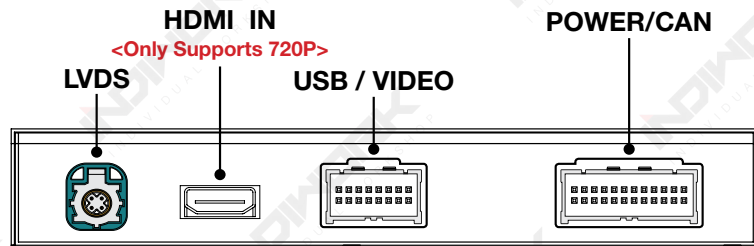

POWER / CAN
CAN-GPBENZ1901-K2

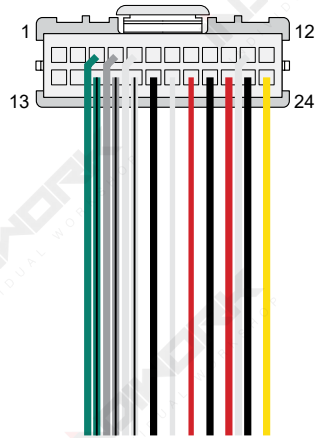

AV CABLE

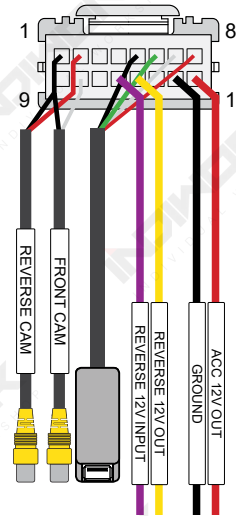

LVDS Cable

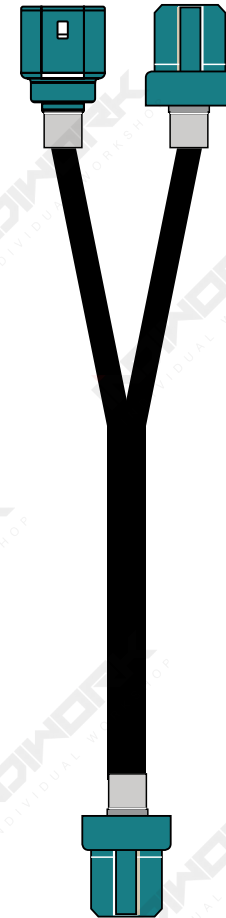

Power / Can Cable			
1	USB1_flag	13	HWCF2_IN_CTL
2	IR_IN	14	BT_RF_C
3	CAN_3_HIGH	15	CAN_3_LOW
4	CAN_2_HIGH	16	CAN_2_LOW
5	CAN_1_HIGH	17	CAN_1_LOW
6	GND	18	GND
7	MIC_IN_N_Car	19	MIC_N
8	MIC_IN_P_Car	20	MIC_P
9	A_R_AMI	21	Audio GND
10	A_L_AMI	22	A_R_AUX_CAR
11	A_L_AUX_CAR	23	GROUND
12	Audio_GND	24	BATTERY POWER INPUT

AV CABLE			
1	CVBS_GROUND	9	
2	REVERSE_CAM_VIDEO_INPUT	10	FRONT_CAM_VIDEO_INPUT
3		11	
4	GROUND_SHIELD	12	REVERSE_12V_INPUT
5	USB_GND	13	REAR_12V_POWER_OUT
6	DATA +	14	
7	DATA -	15	GROUND
8	5V POWER	16	12V(ACC)_OUT

Car Compatibility Chart

Car Models	Specific Models	Production Year	Specific Models	Screen Size
A-Class	W176	2012 ~ 2014	- COMAND APS NTG 4.5 and AUDIO 20	5.8 inch 7 inch
CLA-Class	C117	2014 ~ 2015	- COMAND APS NTG 4.5 and AUDIO 20	5.8 inch 7 inch
B-Class	W246	2012 ~ 2014	- COMAND APS NTG 4.5 and AUDIO 20	5.8 inch 7 inch
C-Class	W204	2011 ~ 2014	- COMAND APS NTG 4.5 and AUDIO 20	5.8 inch 7 inch
SLK-Class	R172	2012 ~ 2014	- COMAND APS NTG 4.5 and AUDIO 20	7 inch
E-Class	W212	2012 ~ 2014	- COMAND APS NTG 4.5 and AUDIO 20	5.8 inch 7 inch
CLS-Class	W218	2011 ~ 2014	- COMAND APS NTG 4.5 and AUDIO 20	7 inch
SL-Class	R231	2012 ~ 2014	- COMAND APS NTG 4.5 and AUDIO 20	7 inch
GLK-Class	X253	2012 ~ 2014	- COMAND APS NTG 4.5 and AUDIO 20	5.8 inch 7 inch
ML-Class	W166	2012 ~ 2014	- COMAND APS NTG 4.5 and AUDIO 20	7 inch
G-Class	X166	2012 ~ 2014	- COMAND APS NTG 4.5 and AUDIO 20	7 inch
GL-Class	W447	2013 ~ 2014	- COMAND APS NTG 4.5 and AUDIO 20	7 inch

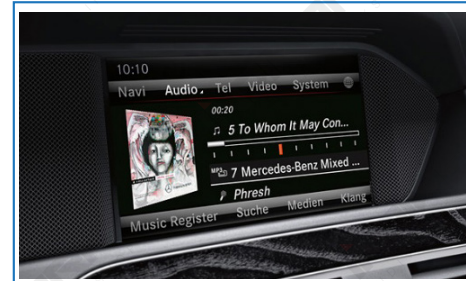

Mercedes NTG4.5 <7 inch>

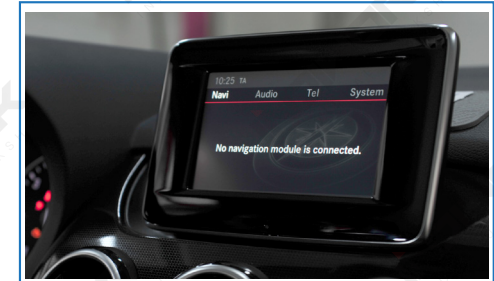

Mercedes NTG4.5 <5.8 inch>



Mercedes NTG4.5 <7 inch>

Full Installation Diagram

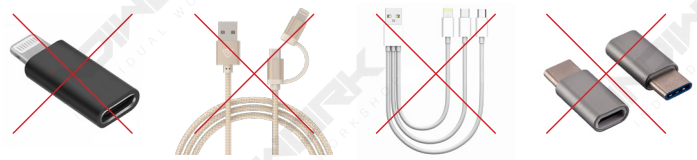

We recommend using for each phone manufacturer genuine cable Please. Never using "Adapter Type and Multi cable"

Apple Car Play
Apple i-phone

Android Auto
Google Android

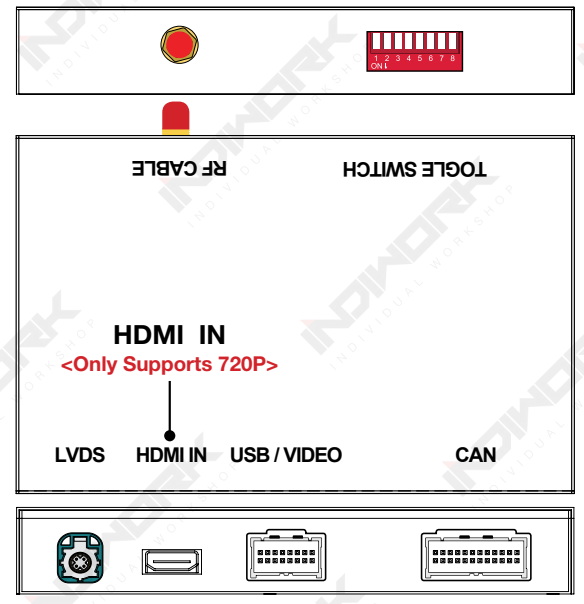

AV Cable

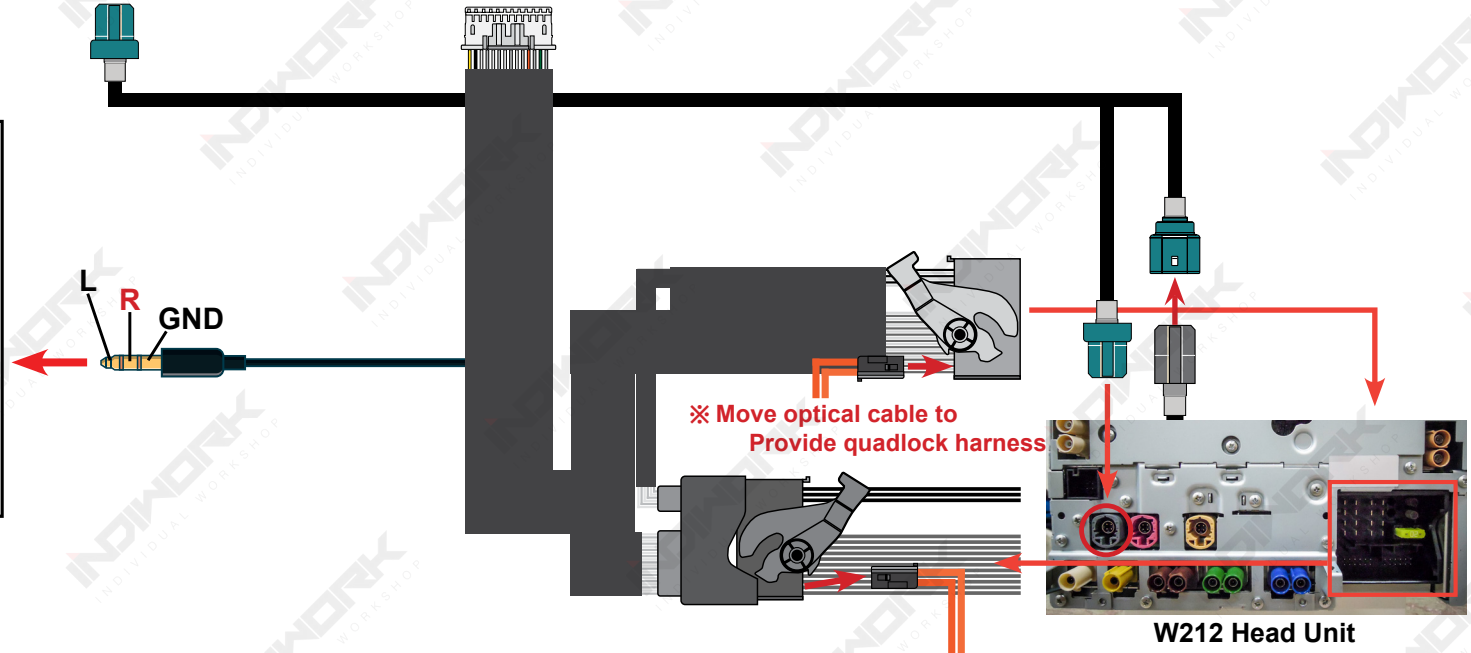
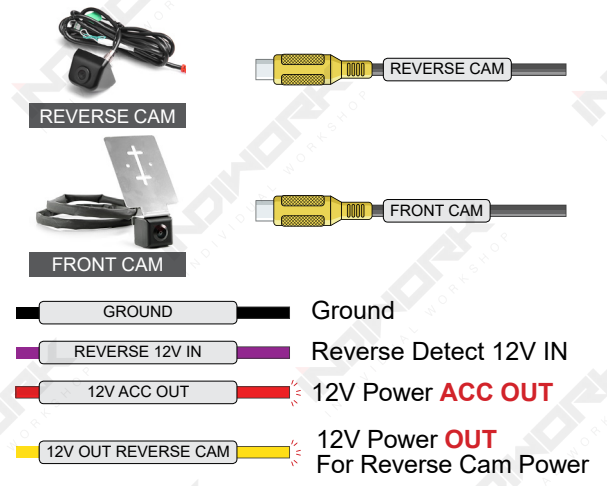

DIP Switch Settings



PIN	ON (▼)	OFF(▲)
1	External Microphone	OEM Microphone
2	Used Default "OFF(▲)"	
3	Selection of car mode	
4		
5	ON (▼) <5.8 Inch 400 X 240>	
6	ON (▼) <7 Inch 800 X 480>	
7	Used Default "OFF(▲)"	
8	Used Default "ON (▼)"	

No.3	No.4	No.5	No.6	Year	Car Model	Code Name	Screen Size
ON (▼)	OFF(▲)	ON (▼)	OFF(▲)	2011 ~ 2014	A-Class	W176	5.8 inch
					B-Class	W246	5.8 inch
					C-Class	W204	5.8 inch
					E-Class	W212	5.8 inch
					GLK-Class	X204	5.8 inch
ON (▼)	OFF(▲)	OFF(▲)	ON (▼)	2012 ~ 2014	E-Class	W212	7 inch
					CLS-Class	W218	7 inch
					GLK-Class	X204	7 inch
					ML-Class	W166	7 inch
					G-Class	W463	7 inch
					GL-Class	X166	7 inch
					SLK-Class	R172	7 inch

Activation by original buttons

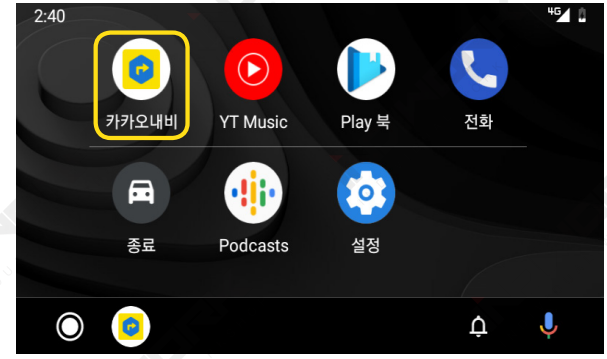
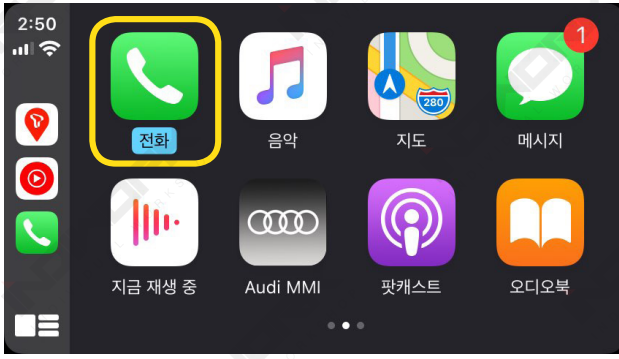

Steering Wheel Button

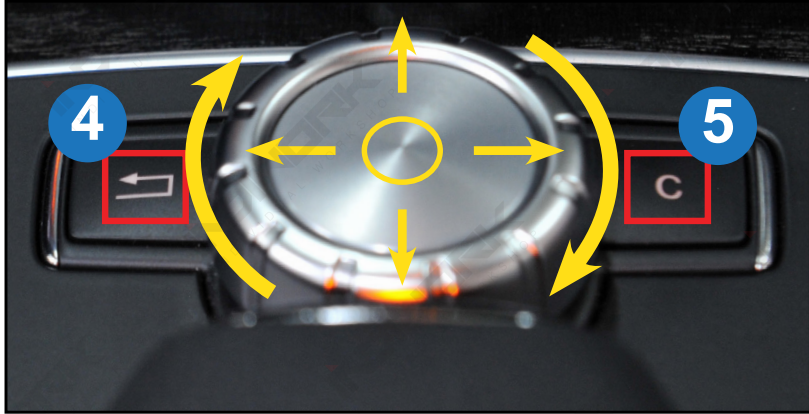

NTG4.5 OEM Buttons

Button	Function	Operation	Remarks
1	Changing Modes	Press the button 3 seconds	Order : OEM → Car Play
		Press the button short time	Return to the OEM mode in any modes.
↕ ↻	Move the pointer Select	Turn the dial	Apple Car Play Function 🍏
		Press the dial	Google Android Auto 🤖
3	Answer Phone Call	Press the button	Apple Car Play Function 🍏 Google Android Auto 🤖
4	Reset	Press the button 5 seconds	Apple Car Play Function 🍏
	Go back	Press the button	Google Android Auto 🤖
5	Changing Modes	Press the button 3 seconds	Order : OEM → Car Play
		Press the button short time	Return to the OEM mode in any modes.
2	"Siri" "Google Assistant"	Press the button 3 seconds	Apple Car Play Function 🍏
			Google Android Auto 🤖

User Interface

Airplay (Apple i-phone mirroring) <WIFI>



It is connected by wifi signal

- Turn on the wifi on the i-phone
- Select Carplayxxxxxx (The wifi name might be deffrent) and connect
- Select "Air play" in the "i-Phone Control Center"
- The smart phone screen will be copy on the car screen

WireAuto (Android Auto) <Cable>



Apple Carplay Wireless,Cable



WirelessDev Setting (Bluetooth)



Wireless Carplay Settings (Bluetooth)
※ Only (Apple i-Phone)

USB Player (Media,Music)

HDMI IN PUT



Android Mirroring <Cable>



Setup <Please Check Next Page>



Front Camera



When it installed front view camera
The user can check front view camera image with it

Settings <System>



Right Drive ON OFF ON = Left Steering Wheel
OFF = Right Steering Wheel

Camera Mirror ON OFF

Switch L/R Key to D/U Key ON OFF

Wheel key swap

- No swap
- Swap
- Invalid

Carplay Left Scrap 0 10

Carplay Left Scrap 0 10

Software Update

- System Update
- MCU Update
- Logo Image Update
- Carplay icon Update

Download Update File

<http://indiwork.co.kr/manual-carplayandroid-auto/>

- Copy the update file "ISPBOOOT.BIN" to the root directory of USB storage.
- Plug in the USB storage on the carplay box USB port
- Select the "System update" or Prees the BACK button 5sec "It will be restart and start update automatically"

Please. Never power off the box on updating

- Copy the update file "Upgrade.bin" to the root directory of USB storage.
- Plug in the USB storage on the carplay box USB port
- Select the "MCU update"

Please. Never power off the box on updating

Logo Image file format

File Name : "no logo.bmp" **Size :** 800 x 480

- Copy the update file "no logo.bmp" to the root directory of USB storage.
- Plug in the USB storage on the carplay box USB port

Carplay icon Image file format

File Name : "no cp_back.png" **Size :** 250 x 250

- Copy the update file "no logo.bmp" to the root directory of USB storage.
- Plug in the USB storage on the carplay box USB port

www. **INDIWORK** .co.kr

Copyright © indiwork. All Rights Reserved.