

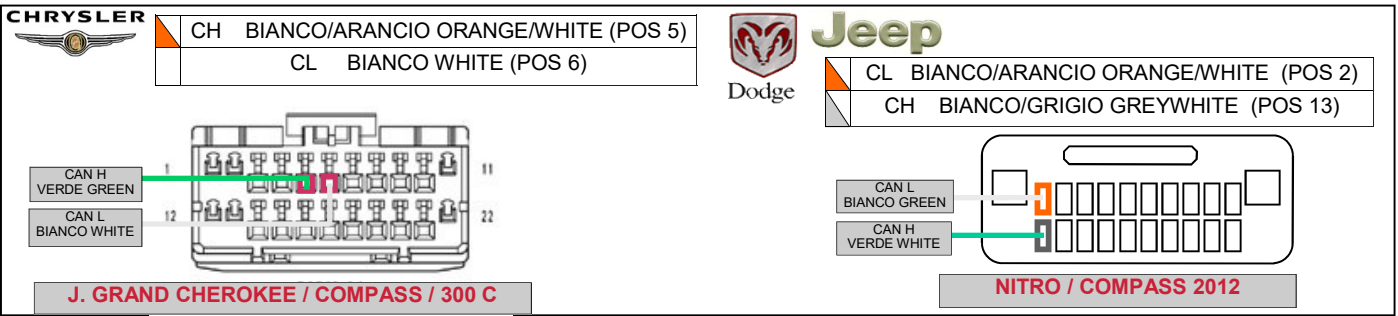

# CONNESSIONI SLIMKEY (VISTA CONNETTORI USCITA FILI) SLIMKEY CONNECTIONS (WIRES OUTPUT VIEW)

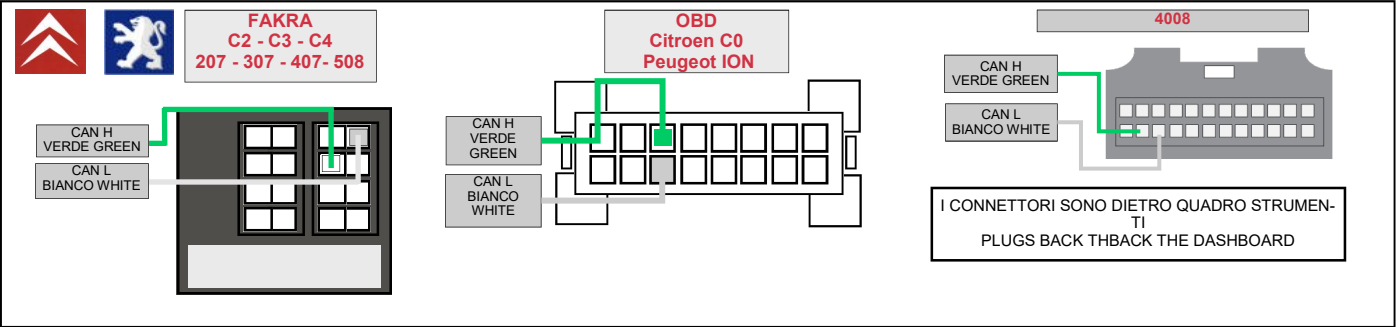
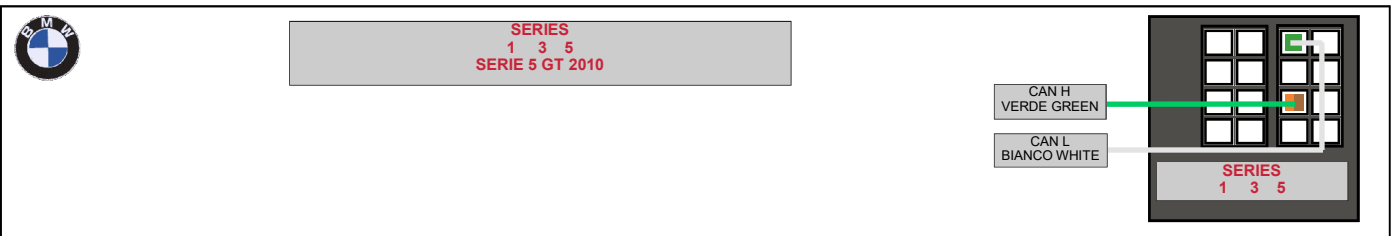
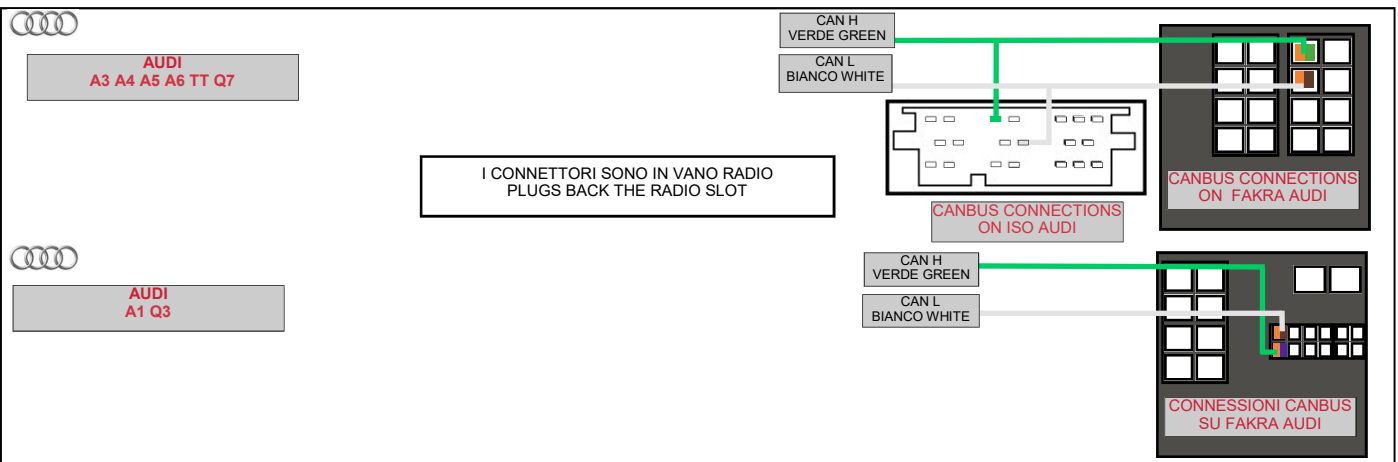
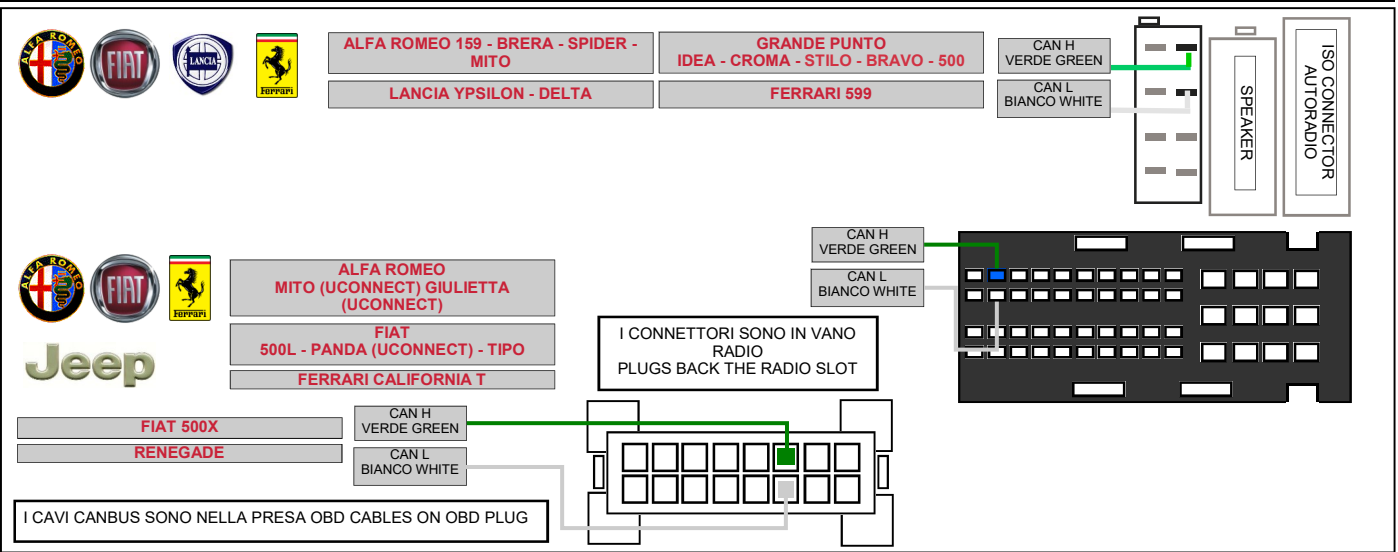

# PASER

## CONNESSIONI SLIMKEY (VISTA CONNETTORI USCITA FILI) SLIMKEY CONNECTIONS (WIRES OUTPUT VIEW)



**CALIFORNIA**

	CL VERDE / GREEN (POS 2)
	CH BIANCO / WHITE (POS 13)

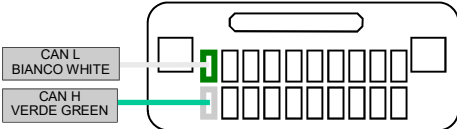



**FREEMONT**

I CONNETTORI SONO IN VANO RADIO  
PLUGS BACK THE RADIO SLOT

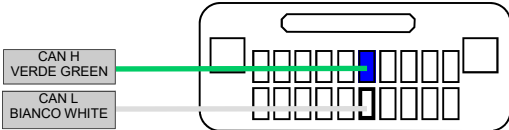



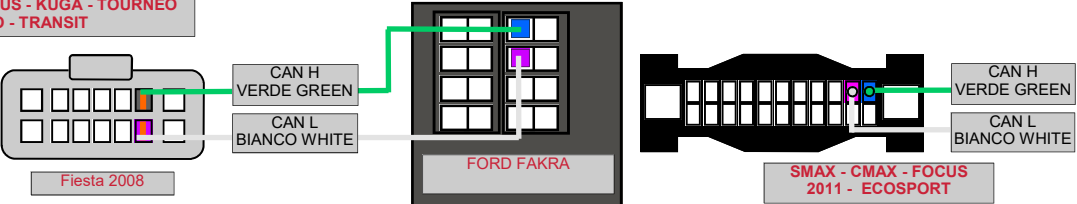

**SMAX - CMAX - FOCUS - KUGA - TOURNEO  
MONDEO - TRANSIT**

I CONNETTORI SONO IN VANO RADIO  
PLUGS BACK THE RADIO SLOT

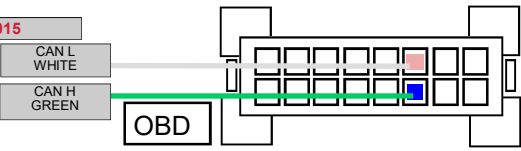

**RANGER 2015**





**TRANSIT 2018**

I CONNETTORI SONO IN VANO RADIO  
PLUGS BACK THE RADIO SLOT

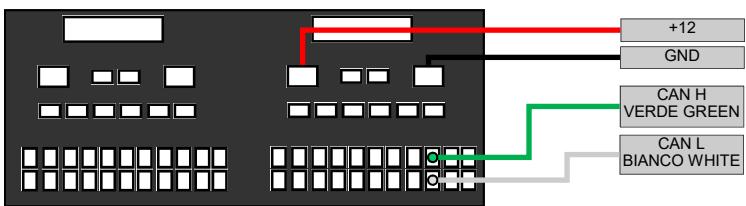



**CRV 2013**

I CONNETTORI SONO IN VANO RADIO  
PLUGS BACK THE RADIO SLOT

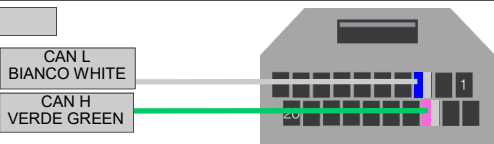

**FRV 2009**

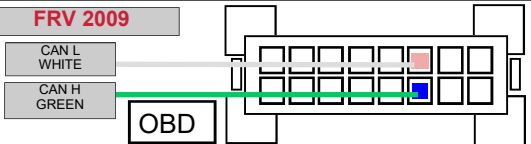



**ix20**

IL CONNETTORE E' SOTTO IL CRUSCOTTO DIETRO LA PARATIA DI PLASTICA  
NEI PRESSI DELLO STERZO / CONNECTOR IS UNDER THE DASHBOARD  
NEAR STEERING WHEEL, BACK A PLASTIC COVER

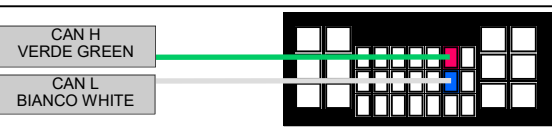





**WRANGLER**

I CONNETTORI SONO IN VANO RADIO  
PLUGS BACK THE RADIO

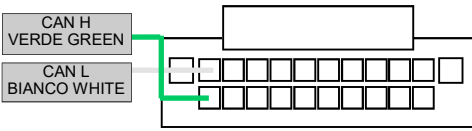
	VERDE		CH BIANCO/ARANCIO (POS 13)
	BIANCO		CL BIANCO (POS 2)





I CONNETTORI SONO IN VANO RADIO  
PLUGS BACK THE RADIO SLOT

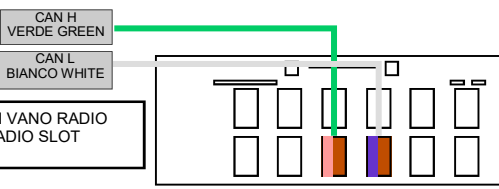

**RANGE ROVER - EVOQUE**

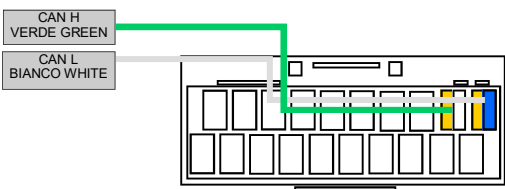

**RANGE ROVER - FREELANDER II**

I CONNETTORI SONO IN VANO RADIO  
PLUGS BACK THE RADIO SLOT

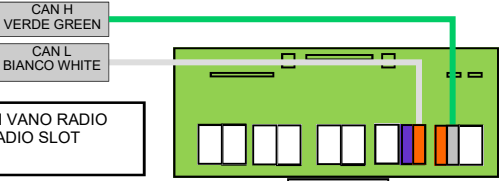

**RANGE ROVER - FREELANDER II**

IL CONNETTORE E' DIETRO IL VANO PORTA OGGETTI  
PLUGS ARE BEHIND THE GLOVES BOX

**PASER**

**CONNESSIONI SLIMKEY (VISTA CONNETTORI USCITA FILI)**  
**SLIMKEY CONNECTIONS (WIRES OUTPUT VIEW)**

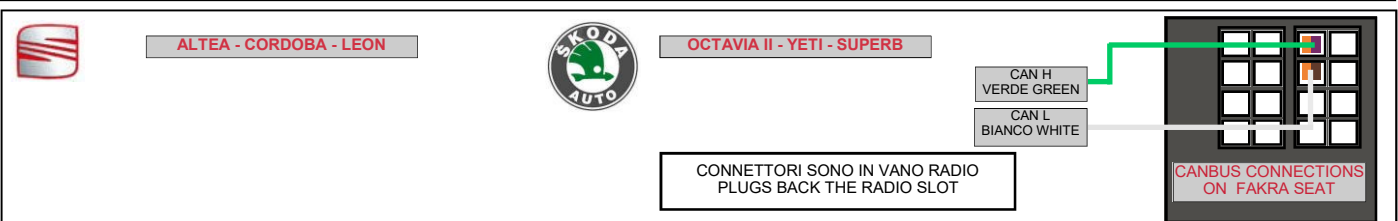
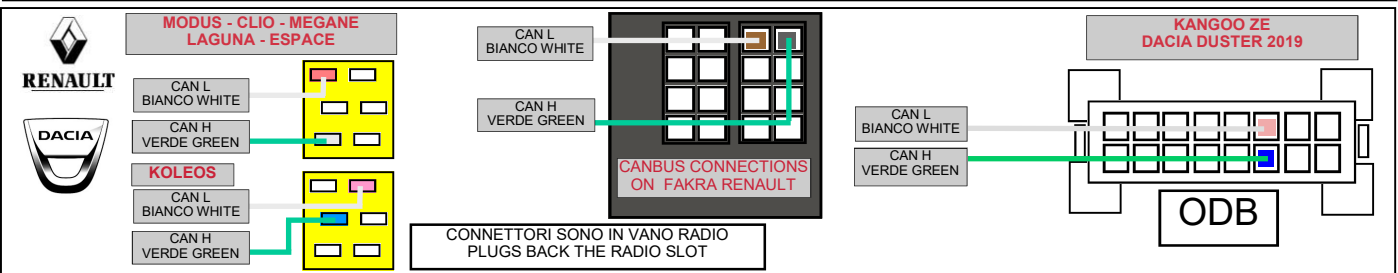
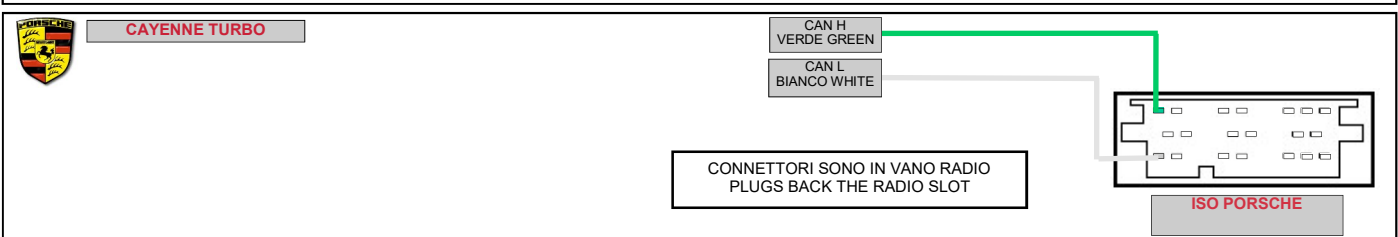
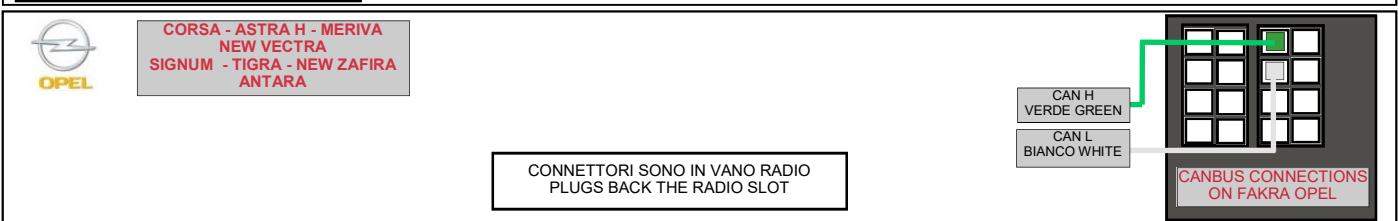
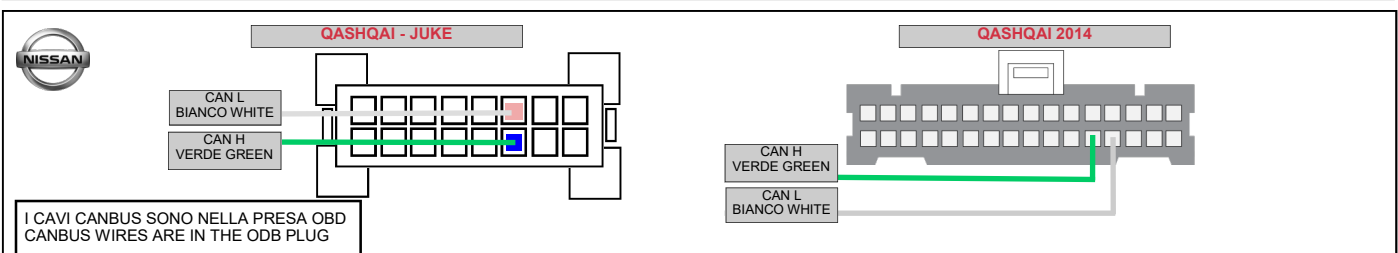
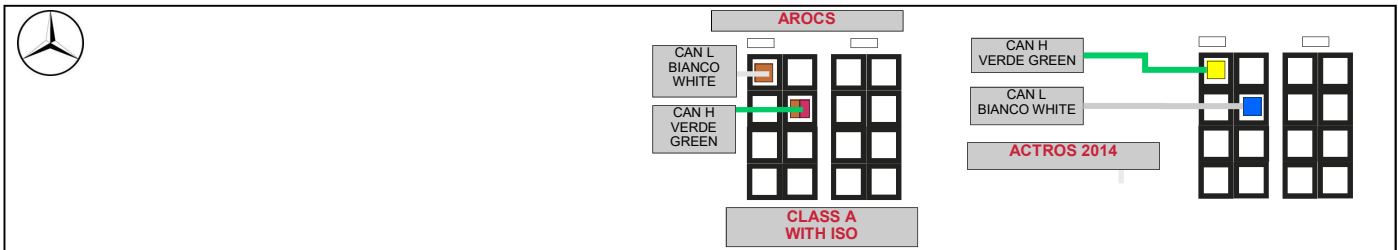
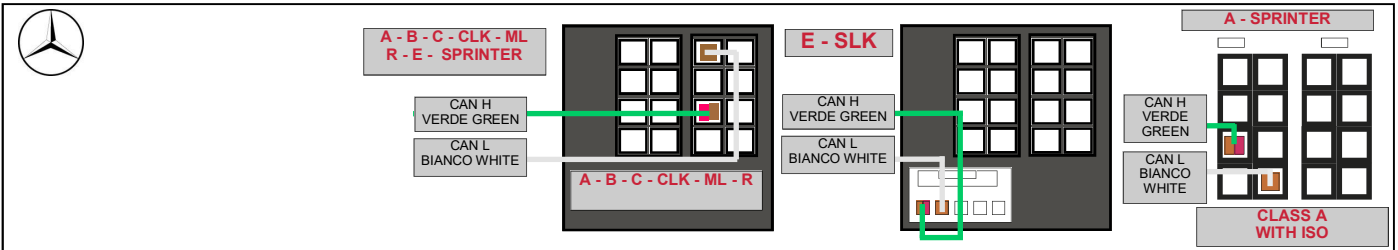



## CONNESSIONI SLIMKEY (VISTA CONNETTORI USCITA FILI) SLIMKEY CONNECTIONS (WIRES OUTPUT VIEW)



I CAVI SONO SOTTO IL CRUSCOTTO LATO GUIDA NELLA ZONA STERZO  
WIRES ARE BELOW THE DASHBOARD NEAR THE STEERING

	VERDE GREEN		CH BIANCO/VERDE WHITE GREEN (POS 6)
	BIANCO WHITE		CL VERDE GREEN (POS 9)



**SSANGYONG - KORANDO 2011>**

I CAVI CANBUS SONO NELLA PRESA OBD  
CANBUS WIRES ARE IN THE ODB PLUG

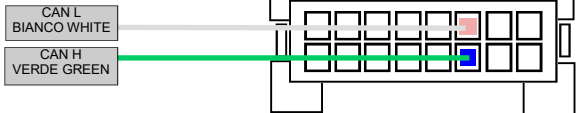



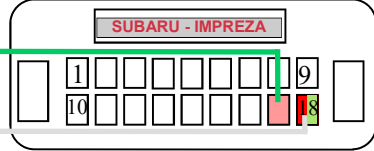

I CONNETTORI SONO IN VANO RADIO  
PLUGS BACK THE RADIO SLOT

**SUBARU - IMPREZA**

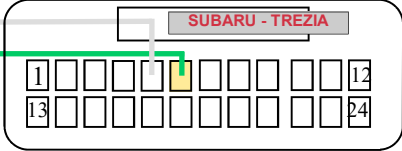

**SUBARU - TREZIA**





**TOYOTA - PRIUS**

I CAVI CANBUS SONO NELLA PRESA OBD  
CANBUS WIRES ARE IN THE ODB PLUG

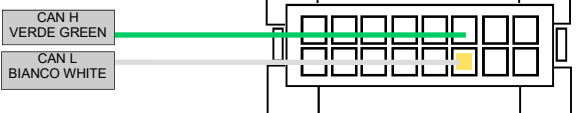



**POLO 2009 - GOLF V - GOLFPLUS - TOURAN - PASSAT - TOUAREG - NEW TOUAREG - EOS**

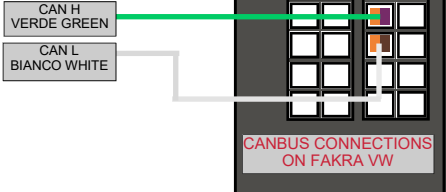



**GOLF VII LEON 2013 OCTAVIA 2013 AUDI A3 2013**

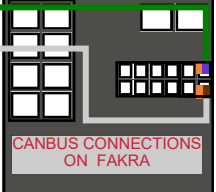

I CONNETTORI SONO IN VANO RADIO O CASSETTO PORTA OGGETTI  
PLUGS BACK THE RADIO SLOT OR BACK THE GLOVES BOX



**V70**

**V40 2013**

CONNETTORI SONO IN VANO RADIO  
PLUGS BACK THE RADIO SLOT

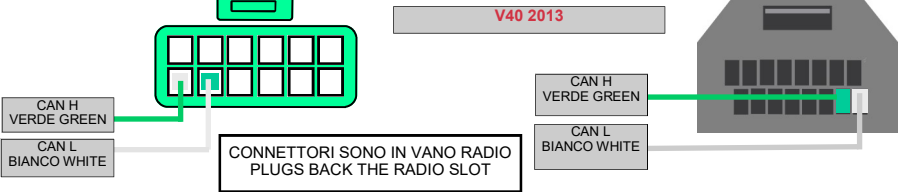

**S80 2014**

**OBD**

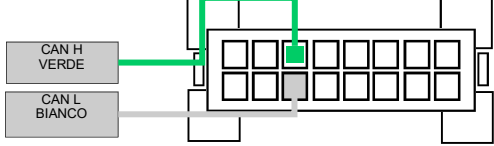



**X3 G01**  
Fascio cavi sotto cruscotto lato guida.  
GIALLO BIANCO CAN H  
GIALLO NERO CAN L  
Dow the dashboard driver side  
YELLOW WHITE CAN H  
YELLOW BLACK CAN L



Le informazioni riportate in questo manuale e nei suoi allegati sono puramente a scopo informativo pertanto possono subire modifiche senza preavviso. Al momento della pubblicazione le informazioni risultano corrette ed attendibili. Tuttavia Paser non può essere ritenuta responsabile per eventuali conseguenze derivanti da errori, omissioni o incongruenze del presente manuale e dei suoi allegati (ad. es. per l'eventuale mancato recupero di configurazioni audio originali dei veicoli). Paser si riserva il diritto di migliorare/modificare il prodotto o il manuale senza l'obbligo di notifica agli utenti.

Information in this guide and its attachments are for information purposes only, therefore, they are subject to change without notice. At the time of publication the information is correct and reliable. However Paser can not be held responsible for any consequences resulting from errors, omissions or incongruence of this manual (for ex. missed audio configuration back-up of the vehicles). Paser reserves the right to improve / change the product or manual without obligation to notify users.